

INSTALLATION INSTRUCTIONS

1. Install the TC158 with the furnished mounting screws to a standard 4-11/16" x 2-1/8" square device box with a 2" x 4" adapter ring.
2. For wall installations, mount the thermostat on an inside wall approximately 5 feet above the floor. Ensure circulation at average room temperature. Avoid direct sunlight or sources of hot or cold air.
3. Remove cover. Mount thermostat base assembly to the outlet box using screws provided, tighten screws evenly, do not over tighten. Connect wires as shown in the appropriate wiring diagram for your thermostat style.
4. To use a remote sensor on units with local sensing capability, remove jumper JP-1. Failure to remove JP-1 will cause improper operation. Sensor wiring must be routed away from any electrical motor or power wiring.
5. Connection of a 24 VAC setback signal will force the control into un-occupied mode (see diagram). Pressing an arrow key or the mode buttons will disable the setback input for one hour.
6. Reinstall the cover assembly. Install cover locking screw provided. Remove the LCD plastic protective film.
7. Checkout: After wiring and installation are complete, energize the system and check the operation. Adjust the thermostat as necessary to complete at least one cycle. Be sure the thermostat and all other equipment are functioning correctly.



CAUTION

- Use copper wire only, insulate or wire nut all un-used leads.
- Care should be used to avoid electrostatic discharge to the microprocessor.
- This unit has configuration jumpers. You may need to re-configure this thermostat for your application. See page 2.



WARNING

- READ THESE INSTRUCTIONS CAREFULLY BEFORE ATTEMPTING TO INSTALL, OPERATE OR SERVICE THIS THERMOSTAT.
- Failure to observe safety information and comply with instructions could result in PERSONAL INJURY, DEATH AND/OR PROPERTY DAMAGE.
- To avoid electrical shock or damage to equipment, disconnect power before installing or servicing.
- To avoid potential fire and/ or explosion do not use in potentially flammable or explosive atmospheres.
- Retain these instructions for future reference. This product, when installed, will be part of an engineered system whose specifications and performance characteristics are not designed or controlled by PECO. You must review your application and national and local codes to assure that your installation will be functional and safe.

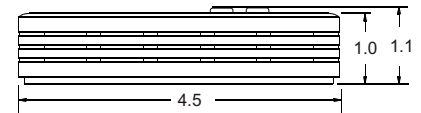
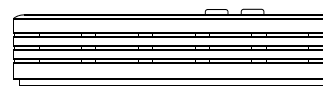
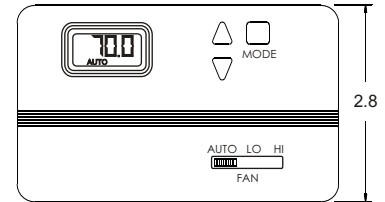
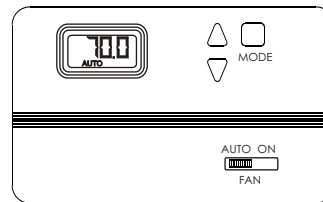

THERMOSTAT OPERATION

MODE BUTTON OPERATION

OFF All thermostat outputs are off, fan is still operational if ON, HI or LO is selected.

AUTO The TC158 automatically selects heating or cooling mode depending upon the relationship of the set point and room temperature. The appropriate HEAT or COOL indicator is enabled in addition to AUTO if demand exists. A 3°F dead-band is provided to prevent short cycling between heating and cooling modes. After change-over the control point automatically shifts so that the control off point equals the set point temperature.

COOL The thermostat operates as cooling only.

HEAT The thermostat operates as heating only.
(If constructed without a mode button, the thermostat operates in AUTO mode.)

FAN SWITCH OPERATION

Fan speed is determined by manual selection of fan switch ON, HI, LO or AUTO. In ON, HI or LO fan output is continuous. In AUTO output cycles with demand. In AUTO and with the MODE in OFF all outputs are off.

OUTPUTS

Demand Output is active anytime the thermostat is actively heating or cooling. Staged Heat Output is active 3°F below first stage heat ON.

SETBACK OPERATION

Unit operates in setback mode when the circuit is closed between terminal #7 and 24 VAC1. When operating in setback mode the control points are 50°F or 60°F for heating and 90°F or 85°F for cooling dependent on dip switch configuration. Fan operation in setback is cycled with demand regardless of fan switch position. See dip switch configuration diagram. Pressing the mode, up or down buttons will override setback for 1 hour.

REMOTE PROBE OPERATION

An optional remote temperature probe can be used. Remove jumper JP1 from the circuit board for proper operation.

NOTE: Outputs may take up to two minutes to respond to changes or on initial power-up.

TYPICAL WIRING

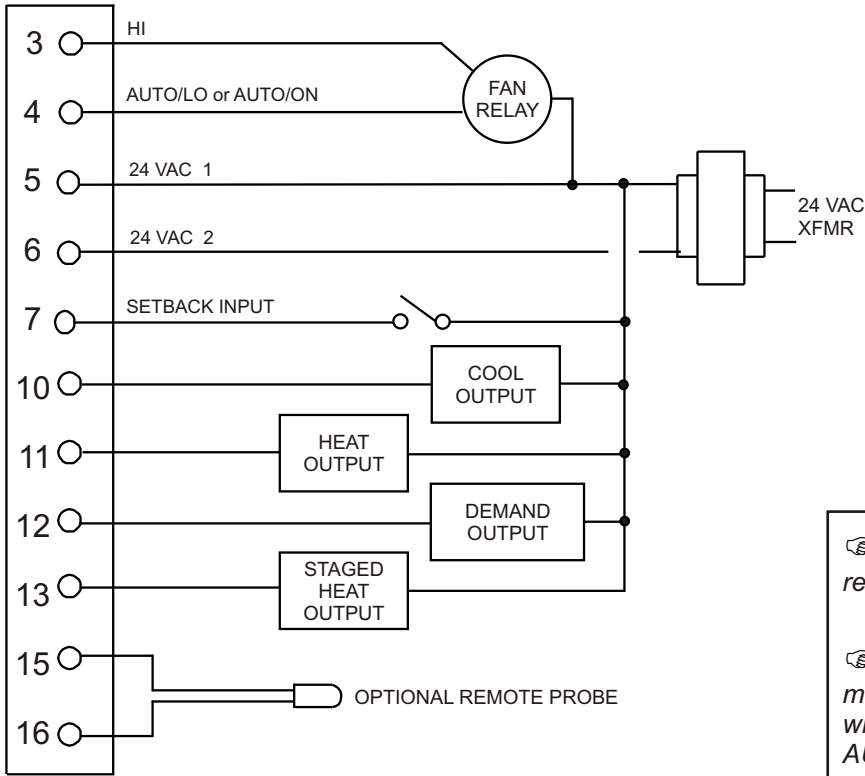

ELECTRICAL RATINGS		
Voltage Rating	Fan Switch	Thermostatic Switching
	Pilot Duty	
24 VAC	10 VA	10 VA

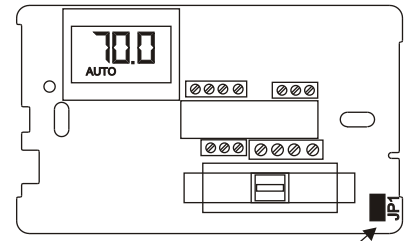
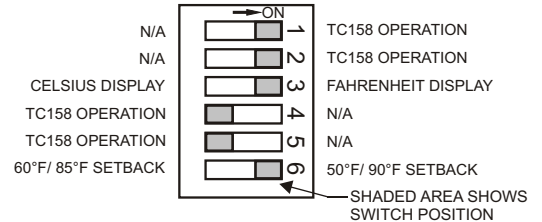

FIGURE 1

NOTE: Jumper JP1 must be removed for remote sensing. See FIGURE 1.

NOTE: The HI fan position is available on all models, but is disabled by the cover on models without a HI position. On models with only ON-AUTO, fan switch must be located in one of those positions for proper cover installation.

DIP SWITCH CONFIGURATION



NO OTHER CONFIGURATION OPTIONS ARE AVAILABLE FOR THE DIP SWITCH

NOTE: Thermostat power must be cycled for changes in dip switch configuration to take effect.

THERMOSTAT OUTPUT OPERATION

- COOL** Cycles on with cooling demand.
- HEAT** Cycles on with heating demand.
- DEMAND** Cycles on with heating or cooling demand
- STAGED HEAT** Cycles on 3°F below first call for heat

NOTE: Specific model configuration may vary the number of connections available.

FAN OPERATION

Models with ON-AUTO Switch Selection:

If AUTO is selected, then terminal 1 output cycles with demand. If LO is selected, then terminal 1 output is fan continuous.

Models with HI-LO-AUTO Switch Selection:

If AUTO is selected, then terminal 1 output cycles with demand. If LO is selected, then terminal 1 output is fan continuous. If HI is selected, then terminal 2 output is on continuous.

NOTE: When thermostat is operating in setback, fan operation is cycled regardless of fan switch position.

Service Menu:

Access: Press UP and DOWN arrows for 5 seconds.

Menu Selection: Select 1 to 5 by pressing the mode button or by pressing the UP and DOWN arrows simultaneously. Items 2,4 and 5 do not apply to this model.

Adjust Value: Use UP or DOWN arrow.

Item #	Function	Range	Default
1	Zone Temp Offset	-5.1F to 5.1F	0F
2	Valve Stroke Time	30 sec. To 5 min.	120 sec.
3	Fan Delay to OFF	0 to 10 Minutes	0 Sec.
4	Compressor Minimum Off Time	30 Sec. To 10 min.	120 Sec.
5	Purge Cycle	0 = Time Based 1 = Temperature Based	1